









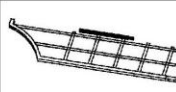
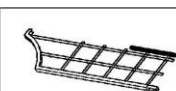

INSTRUCTIONS

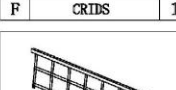

935 Woven Vertical Planter with 3 Baskets

	
A FINIAL 1	H BASKET 1
	
B CRIDS 1	
	
C CRIDS 1	
	
D CRIDS 1	
	
E CRIDS 1	
	
F CRIDS 1	
	
G CRIDS 1	
	
I BOLT 2	J BOLT 2
	
K BOLT 2	L BOLT 6
	
M COCO LINER 3	

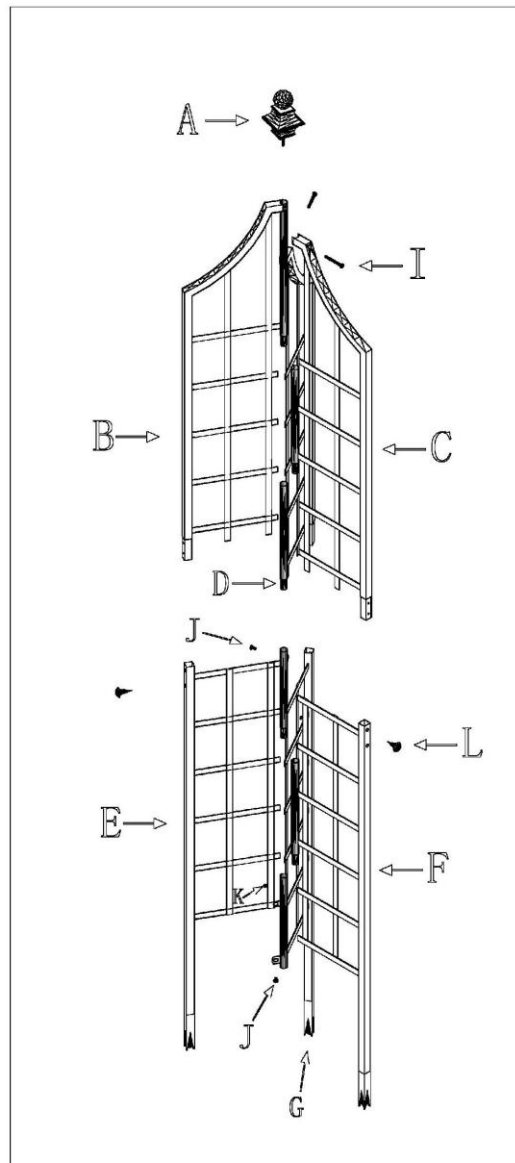

- Tighten all screws and bolts after planter is fully assembled.
- Attach finial A as your last step.
- The planter should be securely anchored into your garden soil.
- We strongly recommend the use of lightweight potting soil when planting the baskets.
- If you have any questions, problems, assembly difficulties or just need to contact us, please call our customer service department at 800/327-4635. Thank you.