

ASSEMBLY DIAGRAM

#939 2 Basket Hanging Vertical Planter with Liners

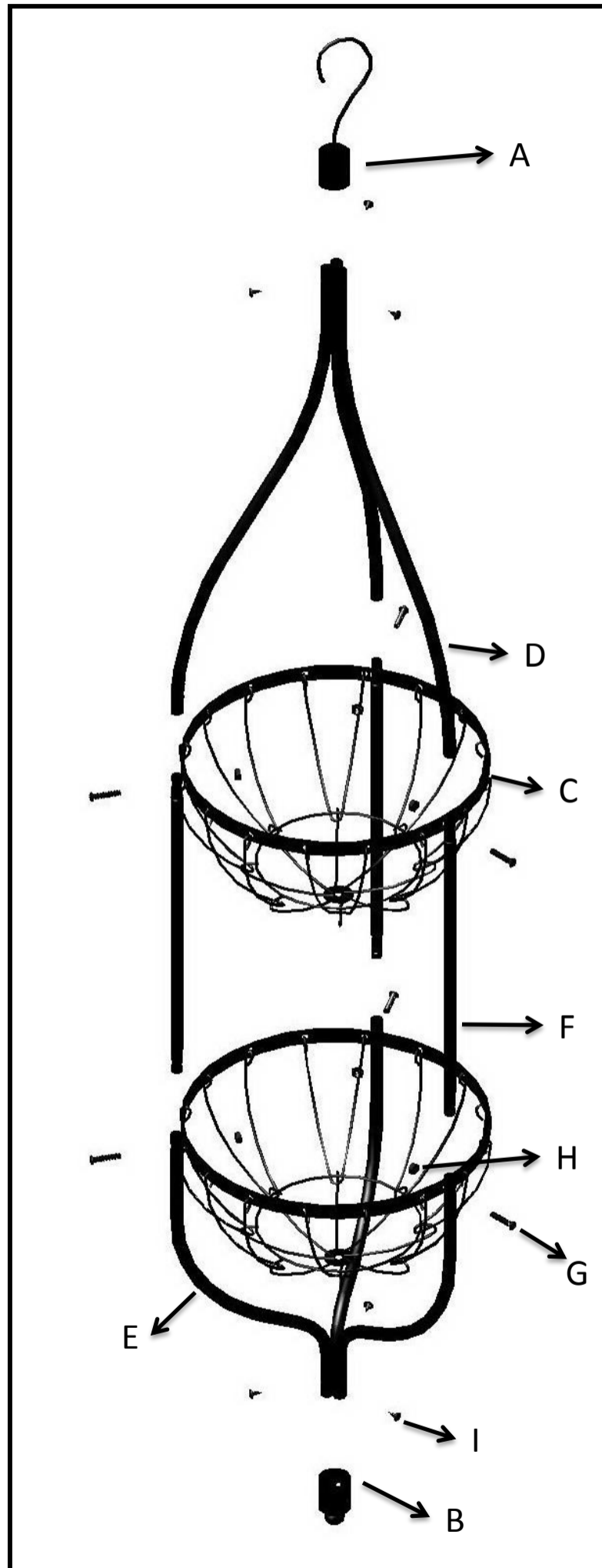
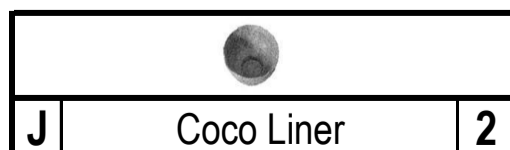
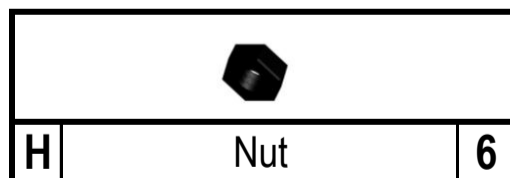
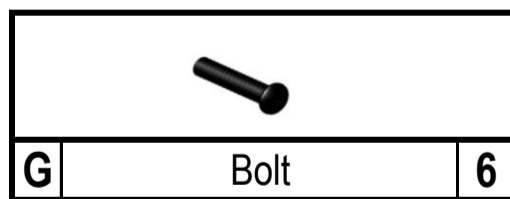
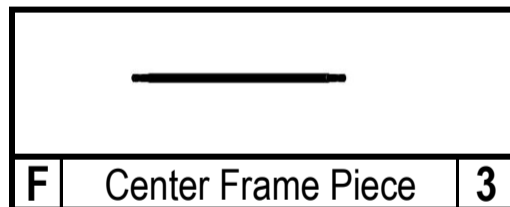
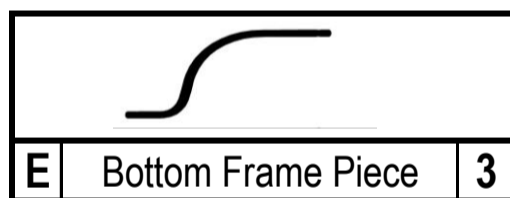
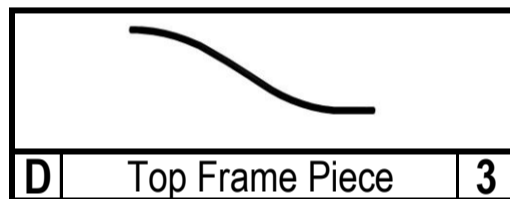
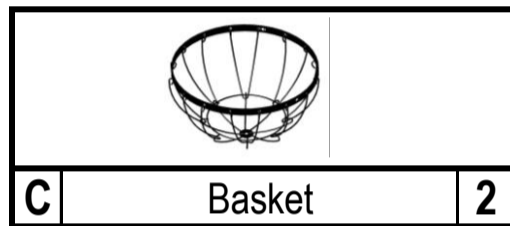
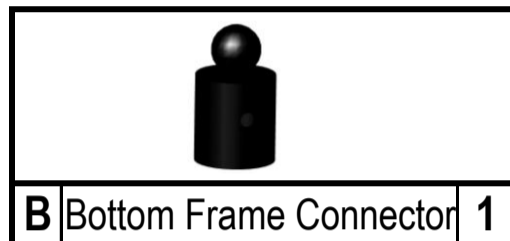
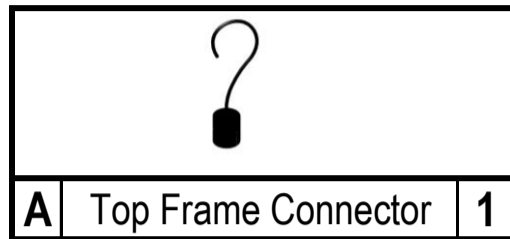

The use of lightweight potting soil is highly recommended. Please contact our customer service department at 800.327.4635 with any questions or concerns.